

## Contents

### Understanding number bonds

Focus 1: Number in subsets

Focus 2: 'Whole' and 'parts'

Focus 3: Find number bonds for 'four'

### Preparing for number bonds within 100

Focus 1: Look at number bonds within 10

Focus 2: More on number bonds within 10

Focus 3: Grouping in tens

Focus 4: Place value for multiples of ten

### Number bonds within 100

Focus 1a and 1b: Using known number bonds within 10 for finding number bonds within 100

Focus 2a and 2b: Finding out unknown numbers in number bonds



**Printable resources can be found at the  
back of the pack.**

# Guidance

## Using the at home materials

This pack contains a series of 15-minute tasks for you to do with your child. Each session has been carefully designed to fit around daily lives.

The tasks help develop number sense and support understanding. There are lots of opportunities to get children to use mathematical vocabulary, explain their reasoning and reveal their thinking.

There is a 'getting started' section in each task for the grown-up to lead. Then there is a task for your child and a suggestion of ways you can explore the ideas further.

## Success for all

At school we believe all pupils can achieve success in maths. We encourage pupils to have a belief that effort leads to success and that challenges are opportunities to learn.

Here are a few tips to encourage your children at home with maths:

- ✓Talk to your children about everyday maths
- ✓Play games with them
- ✓Value mistakes as learning opportunities
- ✓Recognise that there is more than one way to work things out
- ✓Praise children for effort over outcome
- ✓Avoid saying things like "I'm useless at maths"

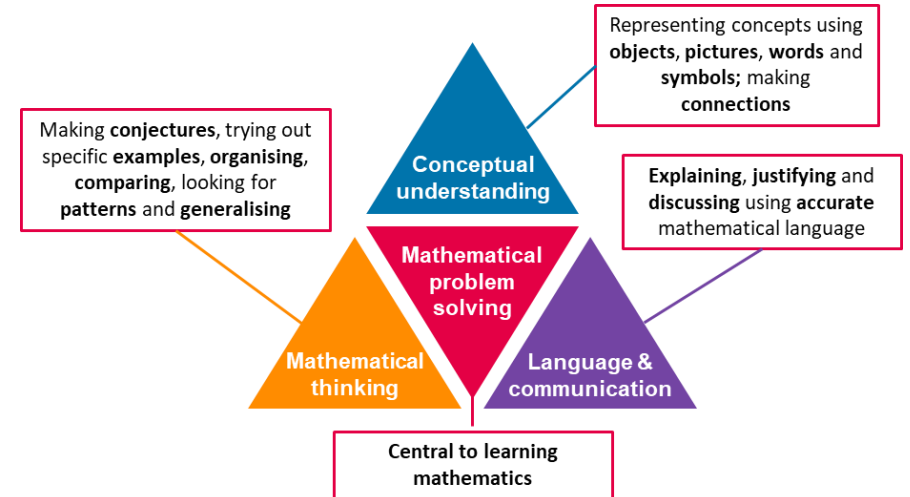

## What is 'Mastery'?

The 'mastery approach' to teaching mathematics is the underlying principle of Mathematics Mastery. Instead of learning mathematical procedures by rote, we want your child to build a deep understanding of concepts which will enable them to apply their learning in different situations. To achieve this we aim to develop pupils' **Conceptual Understanding, Mathematical Thinking and Language and Communication** (see diagram).

## Number Bonds Within 100: Understanding number bonds

### Focus 1: Number in subsets

#### About the maths

Being able to identify the number of objects in sets and subsets is key to developing an understanding of the concept of parts and whole in number bonds.

#### Key words

**Number bonds** are the pairs of numbers that make up a given number.

#### Number Bonds to 10

1 + 9, 2 + 8, 3 + 7, 4 + 6, 5 + 5

#### What you'll need

Lots of objects that could go together for sorting e.g. a set of cutlery with sub-sets of knives and forks, a crockery set with sub-sets of plates and bowls etc.

#### Getting started

Choose a set of objects that can be sorted into two subsets. The example below shows you how you can talk about them together.

*Example:* Explain to your child that the shapes are all squares. Ask them to explain how the shapes have been sorted and label them 'red' and 'not red'.

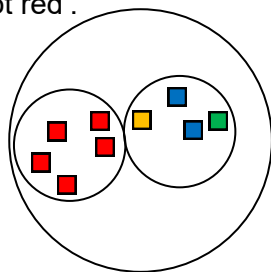

Ask:

How many squares are there in the set?

How many red squares are there in this subset?

How many squares are not red?

#### Task

Give your child a set of objects that have been sorted into subsets.

*Example:* Ask them to identify what they all have in common (they are all triangles).

Ask them to label each subset (green, not green)

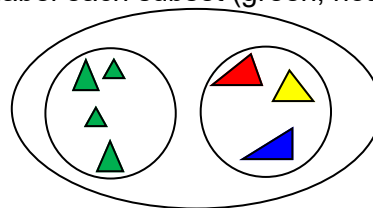

Ask them to identify how many there are in each subset.

Ask them to identify how many there are altogether in the set.

They should be able to identify that:

- there are seven triangles altogether.
- there are four green triangles.
- there are three triangles that are not green.

#### Deepening understanding

Provide your child with shapes that have been sorted into more than two subsets.

Ask them to identify how many there are in the set and how many there are in each subset.

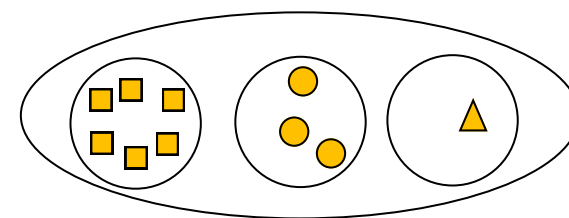

*Example:* They should be able to identify that:

- there are ten orange shapes altogether.
- there are six orange squares.
- there are three orange circles.
- there is one orange triangle.

## Number Bonds Within 100: Understanding number bonds

### Focus 2: 'Whole' and 'parts'

#### About the maths

The concept of 'whole' and 'parts' is a key concept to understanding number bonds and is a concept that your child will apply when learning about different operations.

#### Key words

whole  
part

#### What you'll need

Lots of objects that could go together for sorting e.g. a set of cutlery with sub-sets of knives and forks, a crockery set with sub-sets of plates and bowls etc.

#### Getting started

Choose a set of objects that can be sorted into two subsets. The example below shows you how you can talk about them together.

*Example - Ask:*

How many blue shapes are there in the set?

How many blue triangles are there in this subset?

How many blue circles are there in this subset?

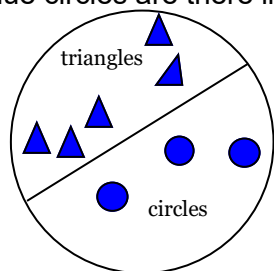

Explain that the set represents the whole and the subsets represent the parts.

#### Task

Give your child four forks and two spoons.

*Example:* Ask them to sort the cutlery into parts.

Ask them to identify how many there are in each them.

Ask them to identify how many there are altogether in the whole.

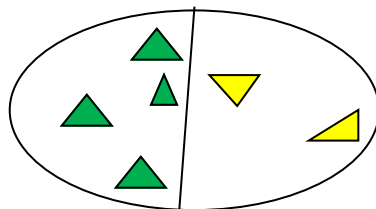

They should be able to identify that:

- the whole is six.
- the parts are four and two.

#### Deepening understanding

Find five objects from the set that can be sorted to illustrate all number bonds within 5. The example below shows how to do this using triangles in different arrangements so that the parts are different for each example.

Say the whole and the parts for each example.

There are five triangles. There are zero squares. Five is the whole. Five and zero are the parts.

There are five triangles. Four are the same. One is different. Five is the whole. Four and one are the parts.

There are five triangles. There are two blue triangles. There are three red triangles. Five is the whole. two and three are the parts.

## Number Bonds Within 100: Understanding number bonds

Focus 3: Find number bonds for 'four'

### About the maths

This tasks will help your child develop their understanding of number bonds. It is important that they explore number bonds using the same set of shapes for the tasks.

### Key words

Set  
Whole, part

### What you'll need

A set of objects that can be put into two subsets, part-whole model

### Getting started

Display your set of objects. Sort the objects into two subsets.

*Example—Ask:*

How many green shapes are there in the set?

What is the whole?

How many green triangles are there in this subset?

How many green circles are there in this subset?

What are the parts?

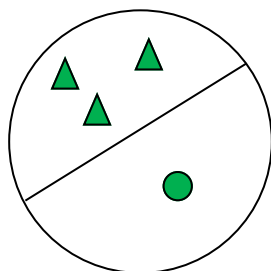

### Task

Give your child a set of objects.

*Example—Ask them to sort them so that they are in two parts.*

For each example, ask them to identify the whole and the parts.

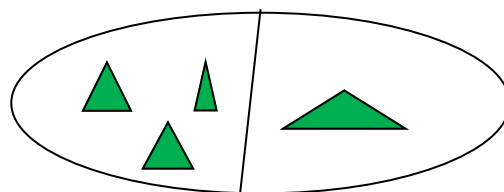

Four is the whole.

Three and one are the parts.



Help them to find **all** number bonds for 4 (0 and 4, 1 and 3, 2 and 2).

### Deepening understanding

Introduce the part—whole model.

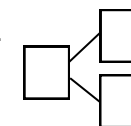

Display one representation of a number bond for four and the part-whole model. Ask your child to identify the whole and record it in the model. Ask them to identify the parts and record them in the model.

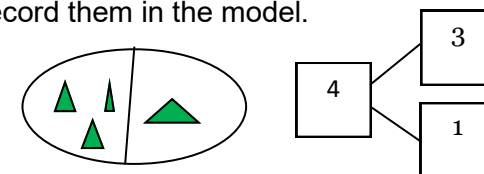

Create a representation for the same number bond for four with the parts on different sides. Discuss what is the same and what is different. As you talk your child should recognise that the whole and the parts are the same but the shapes have been rearranged.

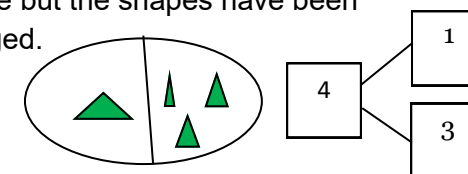

## Number Bonds Within 100: Preparing for number bonds within 100

Focus 1: Look at number bonds within 10

### About the maths

Your child needs a secure understanding of number bonds within 10 before learning number bonds within 100.

### Key words

Rod, colour, equal  
Whole, part

### Things you'll need

Number rods e.g. Cuisenaire ® (printable version included, or you could create your own from paper/card)

### Getting started

These tasks are designed to review number bonds within 10.

Display 5 counters placed into sets to represent the different number bonds for five.

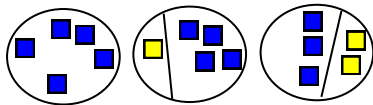

E.g.

Talk about how many there are in each set (five) and in each subset.

Place the counters from each set in a row.

Emphasise that the whole remains is the same (five) and the parts differ in each example. Say what the whole is and what the parts are for each example.

Repeat with number bonds for 4, 3, 2, 1 and 0.

### Task

Use a number rod that represents 4, explaining that the number rod represents the whole (four).

Give your child two rods for each number from 0 to 4.

Find the different pairs of rods that are equal to the whole, ask them to find the two parts that are equal to the whole.

Get your child to say what the whole is and what the parts are.

E.g.



Four is the whole.

Three and one are the parts.



Four is the whole.

Two and two are the parts.

Make sure you find all possible number bonds for 4 and then 3.

### Deepening understanding

Display an example of a number bond for six represented using number rods and a part-whole model.

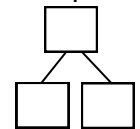

Get your child to tell you which is the whole and which are the parts.

Get them to record the whole and the parts on the model.

Find all possibilities for 7, 8, 9 and 10.



If they record the same numbers more than once, use it as an opportunity to explore how they represent the same number bond.

## Number Bonds Within 100: Preparing for number bonds within 100

### Focus 2: More on number bonds within 10

#### About the maths

A secure understanding of number bonds within 10 will support your child with making connections between number bonds within 10 and within 100.

#### Key words

How many  
Whole, part

#### What you'll need

A string with 20 objects threaded on, e.g. pasta or buttons. This will be your "bead string"

Part-whole model

#### Getting started

Display your "bead string" and a part-whole model.

Explain that the whole is ten and display ten beads.

Talk about how you could use the bead string you have made to find the parts.

Share suggestions and demonstrate how to put the ten beads into two parts.

Record the parts on the part-whole model

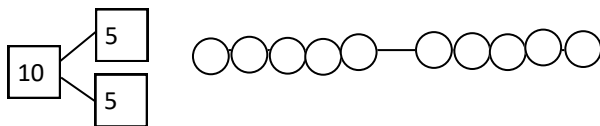

Repeat with all number bonds for 10, 9 and for 8.

#### Task

Ask your child to find the different number bonds for seven using a bead string.

Get your child to use the same seven beads each time so they understand that the whole is the same but the parts change.

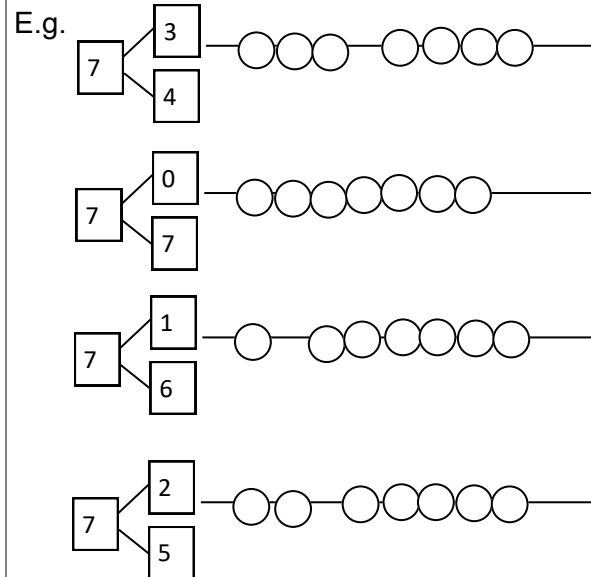

Repeat for all number bonds for 6 and 5.

#### Deepening understanding

Display a part-whole model with the whole and one of the parts written in.

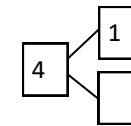

Discuss how the bead string could be used to help find out what the missing part is.

Prompts:

What is the whole? Get your child to represent the whole with the bead string.

What is one of the parts? Ask them to move the same number of beads from the whole as the known part.

How many are there in the other part? Ask them to count the beads in the other part.

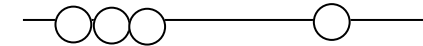

Repeat with any number bond within 10.

## Number Bonds Within 100: Preparing for number bonds within 100

### Focus 3: Grouping in tens

#### About the maths

A secure understanding of place value with numbers within 20 will support your child with making connections between number bonds within 10 and within 100.

#### Key words

Group, groups of  
Exchange, regroup  
ones

#### What you'll need

Dienes (ones cubes and tens sticks) - you can cut these out from the template in this pack.

#### Getting started

Provide your child with a tens Dienes stick (do not tell them that is it a ten).

Ask them to place the ones Dienes cubes alongside each other to find out how many ones Dienes are equal to a tens Dienes.

Ensure that they recognise that ten ones are equal to one ten.

Tell them that the longer stick is called a ten because it has the same value as ten ones, it is equal to one group of ten.

Tell them that the smaller cube is called a one because it has the value of one.

Display 10 ones. Model how to regroup ten ones for one ten and find out how many ones there are left.

Record it in the table.

10

Tens	ones
1	0

#### Task

Provide them with 20 ones and two tens. Ask them to explore grouping 20 ones into two groups of ten ones. Then swap (regroup) each group of 10 ones cubes into 1 ten stick. You will be left with 2 ten sticks. Ask your child to record their answers in a table

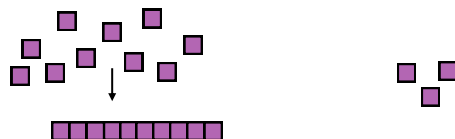

20

tens	ones
2	0

Repeat with 30, 40 and 50.

#### Deepening understanding

Display the numbers 1 and ten next to each other and create representations of the numbers using Dienes before completing the place value table.

1

tens	ones
0	1

10

tens	ones
1	0

Discuss the similarities and differences between the numbers.

Repeat with 2 and 20, 3 and 30, 4 and 40, 5 and 50, 6 and 60, 7 and 70, 8 and 80, 9 and 90.



## Number Bonds Within 100: Preparing for number bonds within 100

### Focus 4: Place value for multiples of ten

#### About the maths

A secure understanding of place value for multiples of ten will support your child with making connections between number bonds within 10 and within 100.

#### Key words

Group, groups of  
Regroup  
Tens, ones

#### What you'll need

Dienes (ones cubes and ten sticks)  
Bead string or other resource with 100 items threaded onto string e.g. pasta, buttons

#### Getting started

These tasks should be repeated for each pair of numbers (1 and 10, 2 and 20, 3 and 30, 4 and 40, 5 and 50, 6 and 60, 7 and 70, 8 and 80, 9 and 90, 10 and 100)

This example is for 5 and 50.

Give your child a bead string.

Explain that each bead represents one.

Explain and highlight how the beads on the string have been arranged into groups.

Ask them to find out how many beads there are in one group.

Ensure that they know the bead string has been grouped into tens.

Ask them to show you one bead, ten beads and then 5 beads and 50 beads.

Discuss how they know they have the correct number of beads.

#### Task

Give your child these partially completed place value charts and ask them to find out the missing number.

tens	ones
0	5

Tens	ones
5	0

Ask them to explore the numbers represented on the place value chart and discuss how they are the same and how they are different.

Ask them to represent the numbers using a bead string and discuss how they are the same and how they are different.

As you discuss it should be clear that 50 has five groups of ten and that 5 has five groups of one.

#### Deepening understanding

Ask your child to represent five using Dienes blocks. Ask them to represent 50 using Dienes blocks.



If your child tries to count in ones for 50, spend more time regrouping ten ones for one ten, and counting in multiples of ten to ensure they understand the value of one ten and to ensure that they know the sequence of numbers when counting on in multiples of ten.

Discuss the similarities and differences between the two numbers.



Check your child recognise that 5 is five ones and 50 is five tens.

Both numbers have one five. The five in 50 represents the number of tens. The five in 5 represents the number of ones.

## Number Bonds Within 100: Number bonds within 100

Focus 1a: Using known number bonds within 10 for finding number bonds within 100

### About the maths

Links between knowledge of place value within 100, known number bonds within 10 and number bonds within 20 should be made clear so your child can find efficient methods for finding number bonds within 20.

### Key words

Dienes, tens, ones  
Bead string  
Whole, part

### What you'll need

Dienes  
Part-whole model  
Bead string or other resource with 100 items threaded onto string e.g. pasta tubes, buttons.

### Getting started

These tasks are designed to be explored with the following pairs of numbers (1 and 10, 2 and 20, 3 and 30, 4 and 40, 5 and 50, 6 and 60, 7 and 70, 8 and 80, 9 and 90, 10 and 100).

The example for this guide focuses on number bonds for 40.

Display the number 4 and the number 40 and ask your child to record the number of tens and the number of ones on a place value chart for each number.

Explore what is similar and what is different and ensure that your child recognise that 40 has four tens and that 4 has four ones.

Create a representation of a number bond for 4. Discuss and explore how we can use our known number bonds for 4 and the knowledge that 40 is equal to 4 tens to find number bonds for 40.

### Task

Create all representations for the number bonds for four.

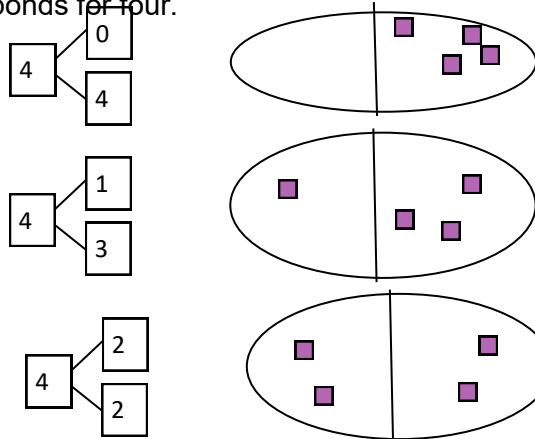

Ask your child to use the known number bonds and knowledge of place value to find some number bonds for 40 using their knowledge of place value. *'If I know  $2 + 2 = 4$ , then I know  $20 + 20 = 40$ '*

For each example, make sure your child uses the same Dienes for 40 each time.

### Deepening understanding

Display an example of a number bond for four and two number bonds for 40 with the whole and one of the parts completed.

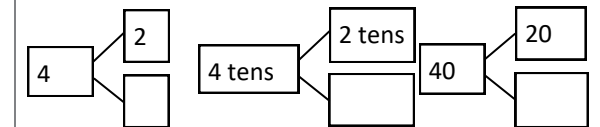

Identify what is known (the whole and one of the parts) and what is unknown (one of the parts).

Refer to their known number bonds for four and identify what the other part would be if four is the whole.

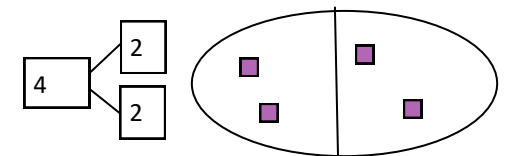

## Number Bonds Within 100: Number bonds within 100

Focus 1b: Using known number bonds within 10 for finding number bonds within 100

...continued

### Getting started

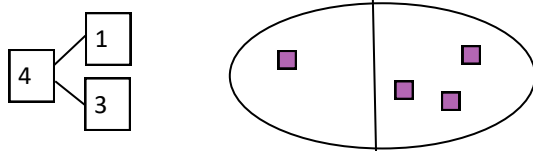

Four is the whole. One and three are the parts.

Four is equal to four ones. Forty is equal to four tens.

If 1 one, plus 3 ones is equal to 4 ones then 1 ten plus 3 tens is equal to 4 tens.

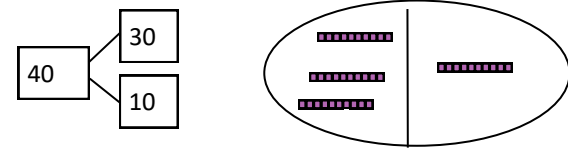
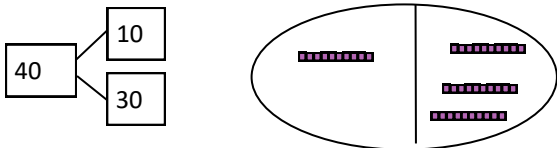

When exploring the number bonds, use the same Dienes to show that the whole remains the same.

For each number bond make links between the number bond for 4 and that 4 is equal to 4 ones and 40 is equal to 4 tens.

### Task

E.g.

Four is the whole. Zero and four are the parts.

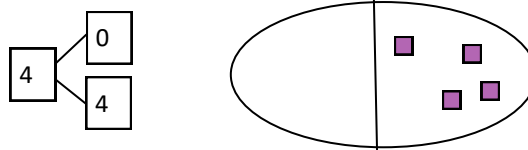

Four is equal to four ones. 40 is equal to 4 tens. If four ones is the whole and, zero ones and four ones are the parts. Then when zero tens and four tens are the parts, four tens are the whole.

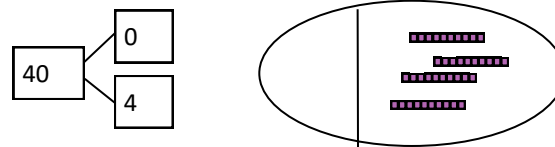
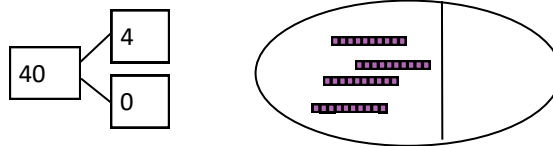

Get your child to find all number bonds they can using known number bonds for four and place value.

### Deepening understanding

Ask your child to refer to their knowledge of place value and knowledge of number bonds for four and identify what the other part would be if there were four tens as the whole.

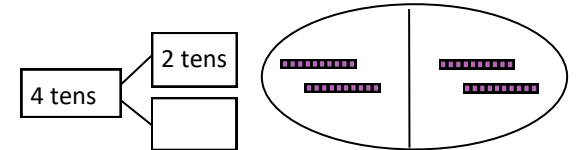

Ask your child to refer to their knowledge of place value, multiples of ten and knowledge of number bonds for four and identify what the other part would be if forty is the whole.

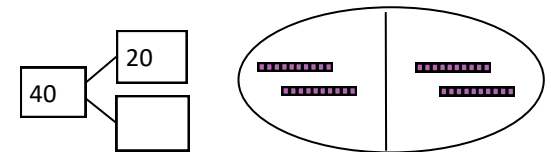

Continue to make links between number bonds within 10, place value and number bonds within 100.

## Number Bonds Within 100: Number bonds within 100

Focus 2a: To be able to find out unknown numbers in number bonds

### About the maths

Your child's understanding of number bonds will develop through exploring number bonds in a variety of ways. Try and talk about the 'whole' and the 'parts' throughout these tasks.

### Key words

How many  
Whole, part

### What you'll need

Part-whole model  
Bead string or other resource with 100 items threaded onto string e.g. pasta tubes, buttons.

### Getting started

These tasks help you both explore each multiple of ten 10-100.

The example for this guide focuses on number bonds for 40.

Have a bead string and a part-whole model ready.

Show that the whole is forty and count out forty beads by counting in multiples of ten. Highlight that there are four groups of ten beads.

Talk about how a bead string could be used to help us find the parts.

Share suggestions and model how to put the forty beads into two parts, ensuring that each part is a multiple of ten.

Write the parts on the part-part-whole model

E.g.

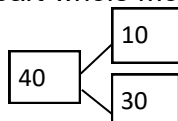

### Task

Ask your child to find the different multiple of ten number bonds for 40 using a bead string.

For each example, get them to use the same 40 beads to reinforce that the whole is the same and that the parts change.

For each example, try and encourage a systematic approach to reinforce that, when one part decreases by ten, the other part increases by ten when the whole is the same.

E.g.

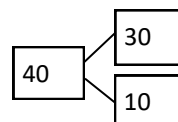
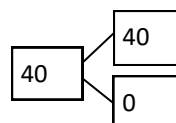

### Deepening understanding

Display a part-whole model with the whole and one of the parts recorded.

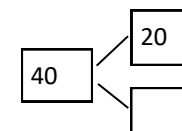

Discuss how the bead string could be used to help us to find out what the missing part is.

Prompts:

What is the whole? Get your child to represent the whole with the bead string.

What is one of the parts? Get your child to move the same number of beads from the whole to represent one part.

How many are there in the other part? Ask them to count the beads in the other part.

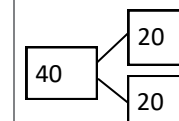

## Number Bonds Within 100: Number bonds within 100

Focus 2b: To be able to find out unknown numbers in number bonds

...continued

### Getting started

Starting with the whole as one of the parts, display the part-whole model with the whole and one of the parts shown. Show representation of the whole and the parts using a bead string.

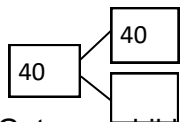

Get your child to use the bead string to find out what the missing part is.

Move one group of ten beads from the part to show a different number bond. Talk about how each part has changed.



Highlight that, when one part decreases by one group of ten, the other part increases by one group of ten when the whole is the same.

Repeat with another example using a systematic approach. Each time highlighting that when one part decreases by one group of ten, the other part increases by one group of ten when the whole remains the same.

### Task

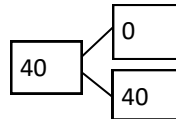
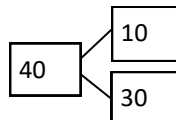
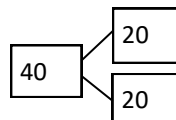

Get your child to keep going until they have all of the number bonds for the whole.

Once they have found all of the number bonds, ask them to identify the part-whole models that have the same parts but in a different order.

i.e.

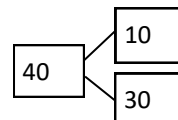
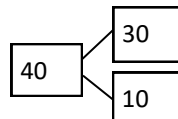
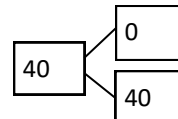
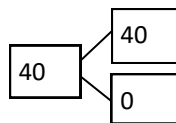

### Deepening understanding

Repeat with other examples for number bonds for 40 making explicit links between the number bonds for 4 and place value.

E.g.

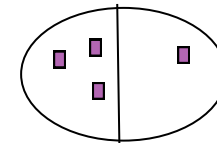
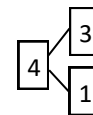
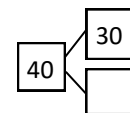

4 is the whole, 1 and 3 are the parts.

There are 4 ones in 4. 3 ones and 1 one are the parts.

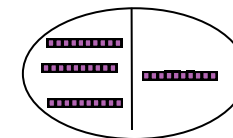
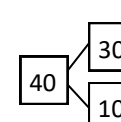

There are 4 tens in 40. 3 tens and 1 ten are the parts.

You can show the whole and the parts with a bead string as well as with Dienes.



Part-whole model

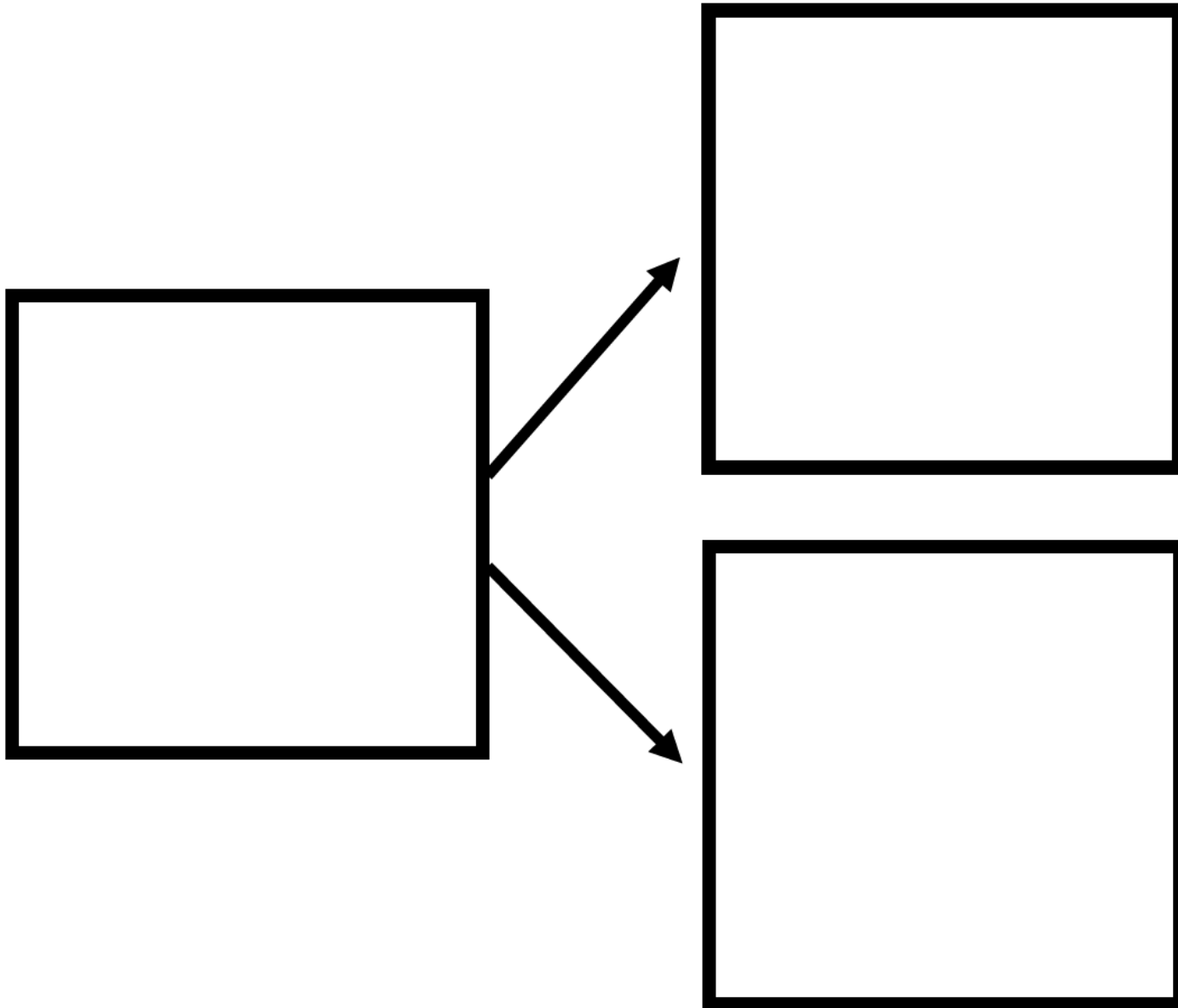





# Cuisenaire

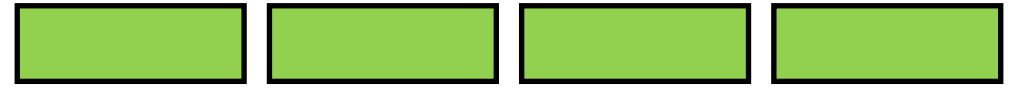
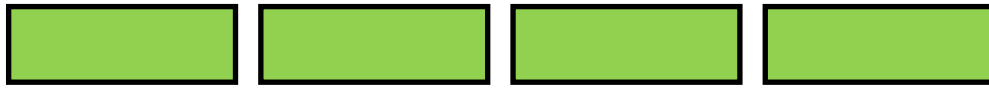
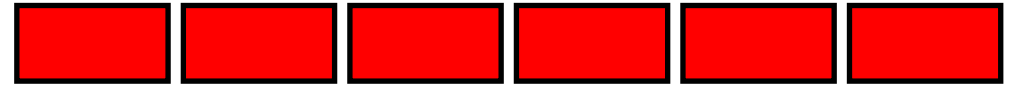
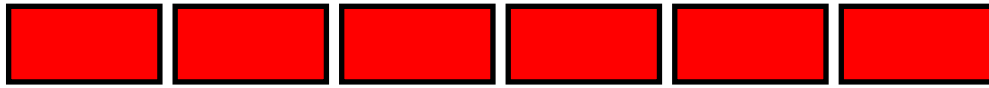
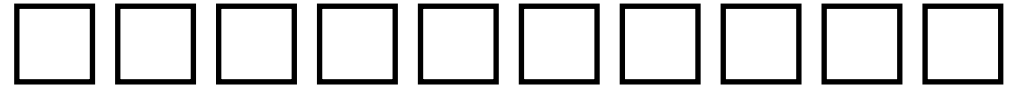
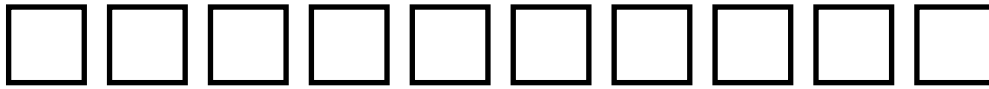



## Counters

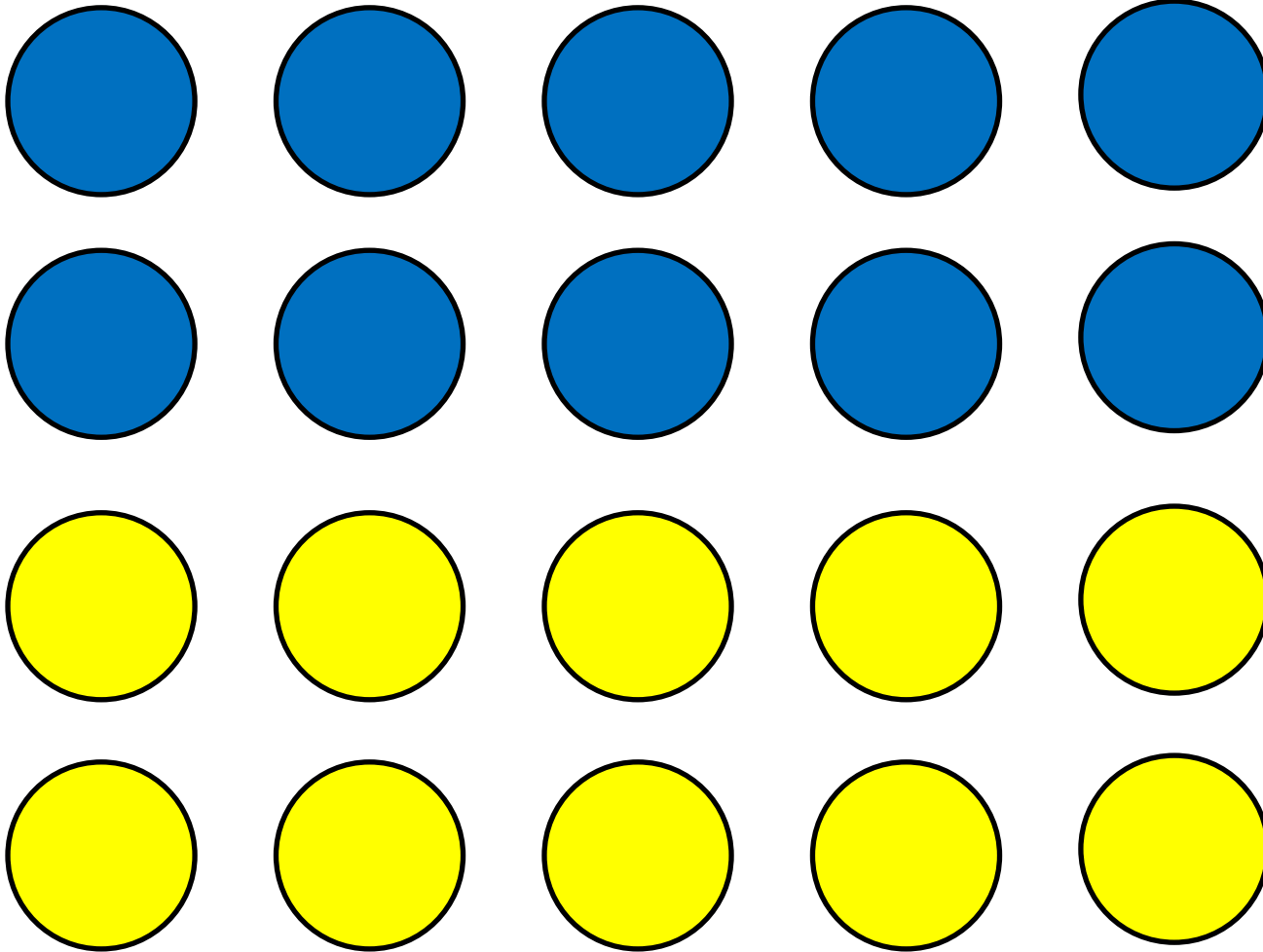



# Dienes

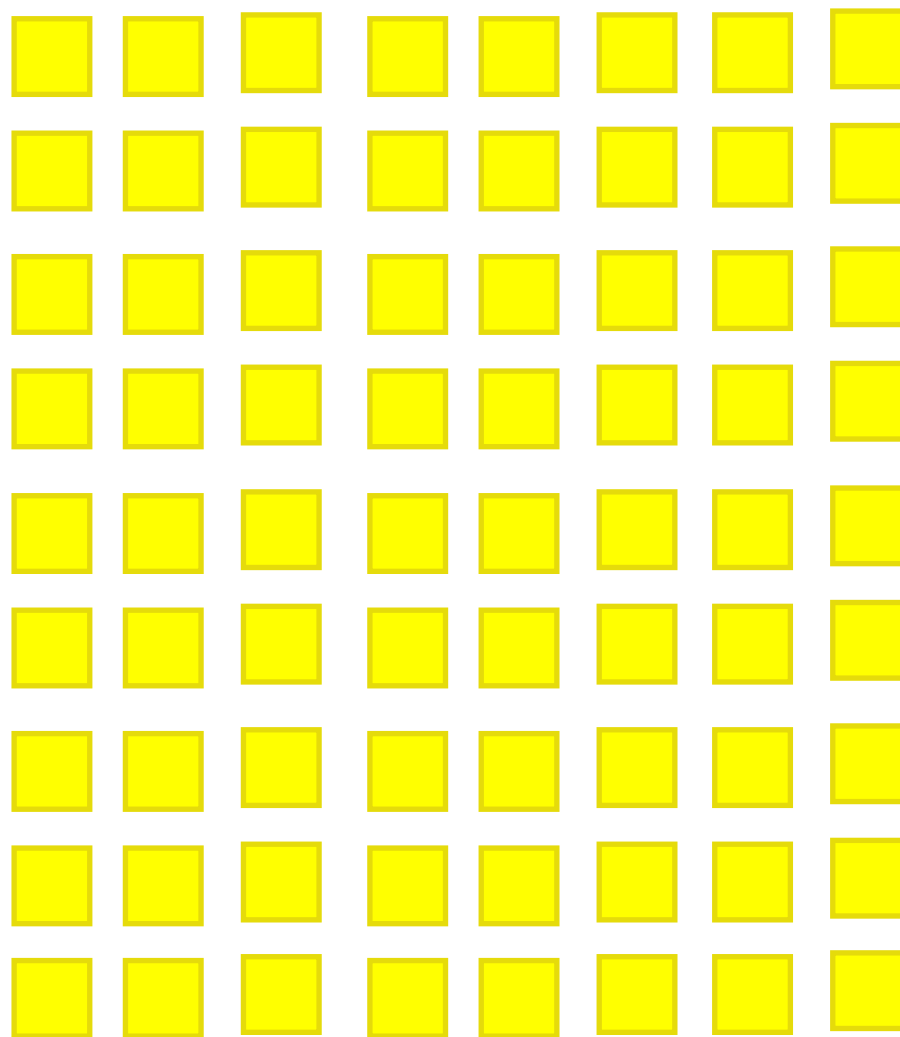
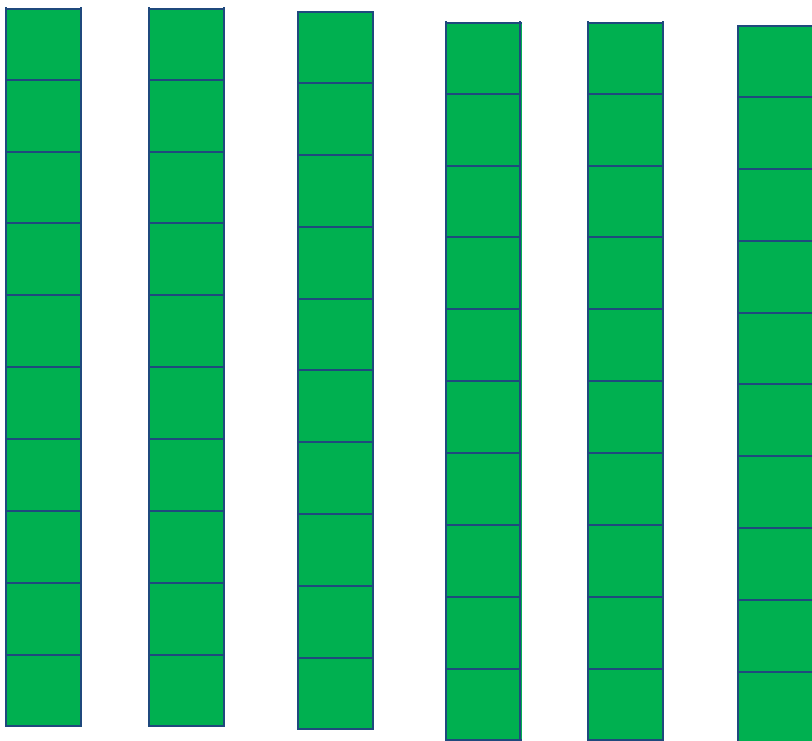

Place value chart

<b>Tens</b>	<b>Ones</b>